

*SD card real time datalogger*

# **HUMIDITY/BAROMETER/ TEMP. METER**

**Model : MHB-382SD**



Your purchase of this HUMIDITY/BAROMETER/TEMP. MONITOR with S D C A R D DATALOGER marks a step forward for you into the field of precision measurement. Although this DATALOGER is a complex and delicate instrument, its durable structure will allow many years of use if proper operating techniques are developed. Please read the following instructions carefully and always keep this manual within easy reach.

**OPERATION MANUAL**

# TABLE OF CONTENTS

1. FEATURES.....	1
2. SPECIFICATIONS.....	1
3. FRONT PANEL DESCRIPTION.....	4
3-1 Display.....	4
3-2 Logger button, Enter button.....	4
3-3 ▲ button, Time button.....	4
3-4 ▼ button.....	4
3-5 SET button.....	4
3-6 Humidity/Temp./Barometer sensor.....	4
3-7 Hanging holes.....	4
3-8 Stand.....	4
3-9 Battery cover/Battery compartment.....	4
3-10 Screw for battery cover.....	4
3-11 Reset button.....	4
3-12 RS-232 Output Terminal.....	4
3-13 SD card socket.....	4
3-14 DC 9V power adapter input socket.....	4
3-15 Hanging unit ( with sticker ).....	4
4. MEASURING PROCEDURE.....	5
5. DATALOGGER.....	5
5-1 Preparation before execute datalogger function.....	5
5-2 Datalogger.....	7
5-3 Check time information.....	7
5-4 SD Card Data structure.....	8
6. Saving data from the SD card to the computer.....	9
7. ADVANCED SETTING.....	10
7-1 SD memory card Format.....	11
7-2 Set clock time .....	11
7-3 Set sampling time.....	12
7-4 Set beeper sound ON/OFF.....	12
7-5 Set SD card Decimal character.....	13
7-6 Select the Temp. unit to °C or °F.....	14
7-7 Set RS232 data output ON/OFF.....	14
7-8 Set the unit of Barometer.....	15
8. POWER SUPPLY from DC ADAPTER.....	15
9. BATTERY REPLACEMENT.....	16
10. SYSTEM RESET.....	16
11. RS232 PC serial interface.....	17
12. PATENT.....	18

# 1. FEATURES

- \* Monitor with real time data logger, save the measuring data along the time information ( year, month, date, hou, minute, second ) into the SD memory card and can be down load to the Excel, extra software is no need. user can make the further data or graphic analysis by themselves.
- \* Show Humidity, Temperature and Barometer value in the same LCD.
- \* 0.1 %RH resolution for the humidity reading, 0.1 degree resolution for the Temp. reading.
- \* Used the precision capacitance type humidity sensor, professional and high accuracy for humidity measurement.
- \* Professional barometer, unit : hPa, mmHg, inHg.
- \* SD card capacity : 1 GB to 16 GB.
- \* Large LCD display, easy readout.
- \* Microcomputer circuit, high reliability.
- \* The circuit design are deigned to consider low power consumption and long battery life when use battery power.
- \* DC 1.5V ( UM-4, AAA ) battery x 6 PCs or DC 9V adapter in.
- \* RS232/USB computer interface.
- \* Patented

# 2. SPECIFICATIONS

## ***2-1 General Specifications***

Circuit	Custom one-chip of microprocessor LSI circuit.
Display	LCD size : 60 mm x 50 mm
Measurement	Humidity, Temperature and Barometer
Memory Card	SD memory card, 1 GB to 16 GB.

Datalogger Sampling Time	5/10/30/60/120/300/600 seconds or Auto. * <i>Default sampling time is 60 seconds.</i> * <i>The " Auto " sampling . means when the measuring value is changed ( &gt; <math>\pm 1</math> %RH or &gt; <math>\pm 1</math> °C or &gt; <math>\pm 1</math> hPa ) will save the data one time only.</i>
Data error no.	$\leq 0.1$ % no. of total saved data typically.
Advanced setting	* SD memory card Format * Set clock time ( Year/Month/Date, Hour/Minute/ Second ) * Set sampling time value * Set beep sound ON/OFF. * Decimal point of SD card setting * Set temperature unit to °C or °F * Set RS232 out ON/OFF. * Set the unit of Barometer
Update Time of Display	Approx. 1 second if measuring data is changed.
Data Output	RS 232/USB PC computer interface. * <i>Connect the optional RS232 cable UPCB-02 will get the RS232 plug.</i> * <i>Connect the optional USB cable USB-01 will get the USB plug.</i>
Operating Temperature	0 to 50 °C .
Operating Humidity	Less than 90% R.H.
Power Supply	* .Alkaline or heavy duty DC 1.5 V battery ( UM4, AAA ) x 6 PCs, or equivalent. * .DC 9V adapter input. ( AC/DC power adapter is optional ).
Battery life	If use the new battery ( alkaline type ) and sampling time set to 60 seconds, the battery life will be > one month typically.

Weight	285 g/0.63 LB.
Dimension	132 x 80 x 32 mm ( 5.2 x 3.1 x 1.3 inch )
Accessories Included	Instruction manual..... 1 PC Hanging unit ( with sticker ).....
Optional Accessories	SD Card ( 2 GB ) AC to DC 9V adapter. USB cable, USB-01. RS232 cable, UPCB-02. Data Acquisition software, SW-U801-WIN.

## **2-2 Electrical Specifications (23± 5 °C)**

### **Humidity**

Range	10 % to 90 % R.H.
Resolution	0.1 % R.H.
Accuracy	≥ 70% RH : ± ( 4% reading + 1% RH).
	< 70% RH : ± 4% RH.

### **Temperature**

Range	0 °C to 50 °C, 32 °F to 122 °F.
Resolution	0.1 degree
Accuracy	°C - 0.8 °C. °F - 1.5 °F.

### **Barometer**

<i>Measurement</i>	<i>Range</i>	<i>Resolution</i>	<i>Accuracy @ reading</i>
hPa	10.0 to 1000.0	0.1	± 2 hPa
	1001 to 1100	1	± 3 hPa
mmHg	7.5 to 825.0	0.1	± 1.5 mmHg
inHg	0.29 to 32.48	0.01	± 0.1 inHg

## 3. FRONT PANEL DESCRIPTION

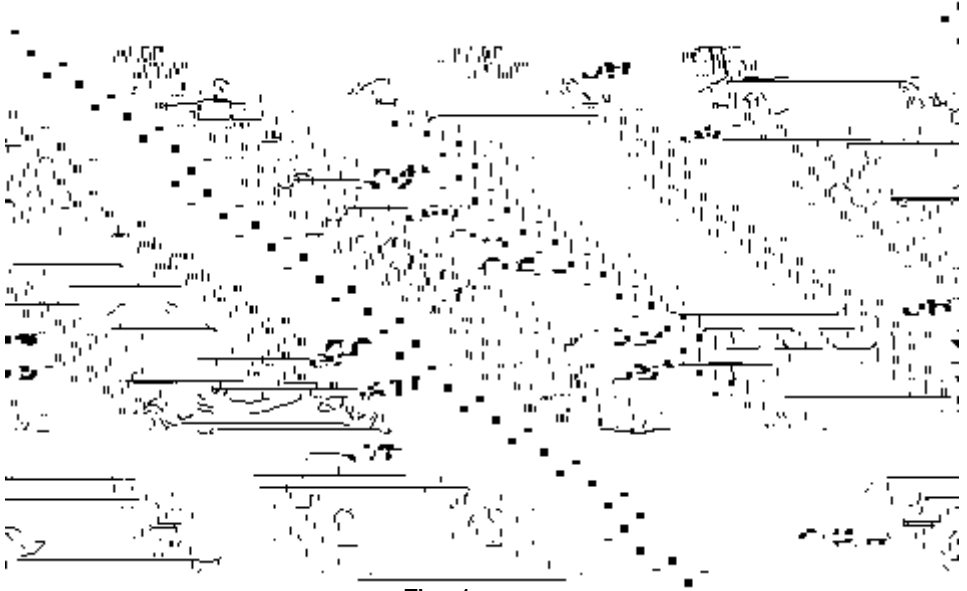

Fig. 1

- 3-1 Display
- 3-2 Logger button, Enter button
- 3-3 ▲ button, Time button
- 3-4 ▼ button
- 3-5 SET button
- 3-6 Humidity/Temp./Barometer sensor
- 3-7 Hanging holes
- 3-8 Stand
- 3-9 Battery cover/Battery compartment
- 3-10 Screw for battery cover
- 3-11 Reset button
- 3-12 RS-232 output terminal
- 3-13 SD card socket
- 3-14 DC 9V power sdapter input socket
- 3-15 Hanging unit ( with sticker )

## 4. MEASURING PROCEDURE

- 1) Install the batteries into the battery compartment :
  - \* Loose the " Screw of the battery cover " ( 3-10, Fig. 1 ) and take away the " Battery Cover " ( 3-9, Fig. 1 ) from the meter.
  - \* Replace with DC 1.5 V battery ( UM4/AAA, Alkaline/Heavy duty type ) x 6 PCs, and reinstate the cover.
  - \* Make sure the battery cover is secured after changing the battery.
- 2) The " Display " ( 3-1, Fig. 1 ) will show both the Humidity, Temperature and Barometer value that sensing from Humidity/Temp./Barometer sensor " ( 3-6, Fig. 1 ).

*Remark :*

- \* *How to change the Temp. unit ( °C, °F ), refer to chapter 7-6, page 14.*
- \* *How to change the Barometer unit ( hPa, mmHg, inHg ), refer to chapter 7-8, page 15.*

## 5. DATALOGGER

### ***5-1 Preparation before execute datalogger function***

a. Insert the SD card

Prepare a " SD memory card " ( 1 GB to 16 GB, optional ), insert the SD card into the " SD card socket " ( 3-13, Fig. 1 ) with the correct direction exactly.

- \* *It recommend use memory card's capacity is  $\leq 4$  GB.*

b. SD card Format

If SD card just the first time use into the meter, it recommend to make the " SD card Format " at first, please refer chapter 7-1 ( page 11 ).

- \* *It recommend strongly, do not use memory cards that have been formatted by other meter or by other installation ( such as camera...) Reformat the memory card with your meter.*
- \* *If the SD memory card exist the trouble during format by the meter, use the Computer to reformat again can fix the problem.*

c. Time setting

If the meter is used at first time, it should to adjust the clock time exactly, please refer chapter 7-2 ( page 11 ).

d. Decimal format setting



The numerical data structure of SD card is default used the "." as the decimal, for example "20.6" "1000.53". But in certain countries ( Europe ...) is used the ",", " as the decimal point, for example " 20, 6 " "1000,53". Under such situation, it should change the Decimal character at first, details of setting the Decimal point, refer to Chapter 7-5, page 13.

e. 3 Information of LCD display

\* If the Display show :

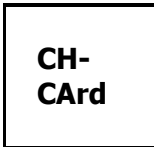

It means that the SD card exist the problem or the SD card memory is full, it should change SD memory card.

\* If the Display show :

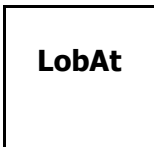

It means that the battery is low voltage. Under such condition, the Datalogger function is disable.

\* If the Display show :

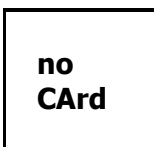

It means that the SD card is not plugged into the meter.



## 5-2 Datalogger

### a. Start the datalogger

Press the " Logger button ( 3-2, Fig. 1 ) > 2 seconds continuously, until the Display show the indicator " DATALOGGER ", release the " Logger Button " ( 3-2, Fig. 1 ), then the measuring data along the time information will be saved into the memory circuit.

#### Remark :

*\*How to set the sampling time, refer to Chapter 7-3, page 12.*

*\*How to set the beeper sound is enable, refer to Chapter 7-4, page 12.*

### c.. Finish the Datalogger

During execute the Datalogger function ( Display show the " Datalogger " indicator ), press the " Logger button " ( 3-2, Fig. 1 ) > 2 seconds continuously, until the Display indicator " DATALOGGER " is disappeared, release the " Logger Button " will finish the Datalogger function.



**Before take away the SD card from the meter, it should execute the procedures of " Finish the Datalogger ", otherwise some existing recent save data may loss.**

## 5-3 Check time information

Press " Time button " ( 3-3, Fig. 1 ) > 2 seconds continuously, the LCD display will present the time information of Year/Month/Date, Hour/Minute/Second and the sampling value.

### **5-4 SD Card Data structure**

1) When the first time, the SD card is used into the meter, the SD card will generate a folder :

#### **HBA01**

2) If the first time to execute the Datalogger, under the route HBA01\, will generate a new file name HBA01001.XLS.

After exist the Datalogger, then execute again, the data will save to the HBA01001.XLS until Data column reach to 30,000 columns, then will generate a new file, for example HBA01002.XLS

3) Under the folder HBA01\, if the total files more than 99 files, will generate anew route, such as HBA02\ .....

4) The file's route structure :

```
HBA01\  
  HBA01001.XLS  
  HBA01002.XLS  
  .....  
  HBA01099.XLS  
HBA02\  
  HBA02001.XLS  
  HBA02002.XLS  
  .....  
  HBA02099.XLS  
HBAXX\  
  .....  
  .....
```

*Remark :*

*XX : Max. value is 10.*

## 6. Saving data from the SD card to the computer ( EXCEL software )

- 1) After execute the Data Logger function, take away the SD card out from the " SD card socket " ( 3-13, Fig. 1 ).
- 2) Plug in the SD card into the Computer's SD card slot ( if your computer build in this installation ) or insert the SD card into the " SD card adapter ". then connect the " SD card adapter " into the computer.
- 3) Power ON the computer and run the " EXCEL software ". Down load the saving data file ( for example the file name : HBA01001.XLS, HBA01002.XLS ) from the SD card to the computer. The saving data will present into the EXCEL software screen ( for example as following EXCEL data screens ) , then user can use those EXCEL data to make the further Data or Graphic analysis usefully.

EXCEL data screen ( for example )

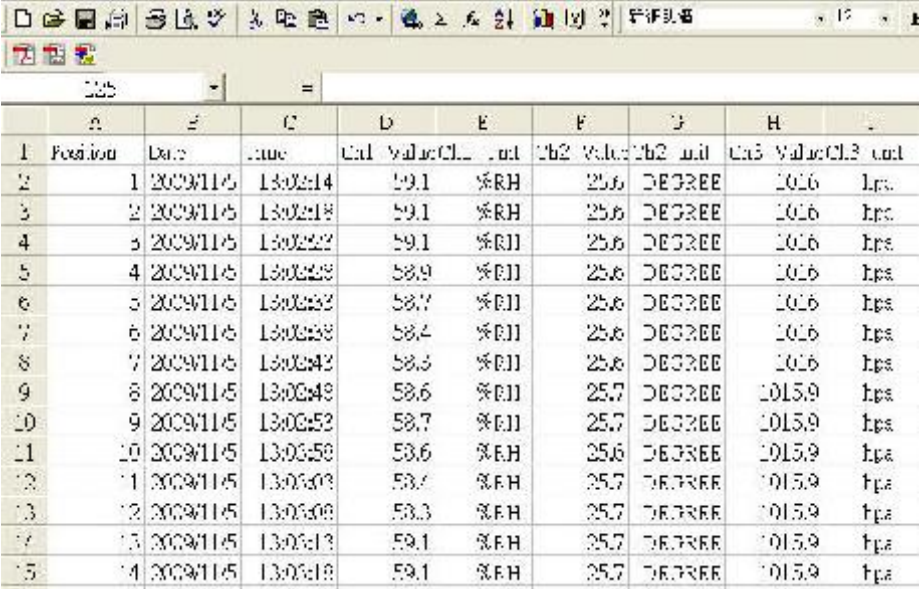

	A	B	C	D	E	F	G	H	I
1	Position	Date	Time	Ch1 Value	CL1 Unit	Ch2 Value	Ch2 Unit	Ch3 Value	CL3 Unit
2	1	2009/11/5	13:02:14	59.1	%RH	25.6	DEGREE	101.6	hpa
3	2	2009/11/5	13:02:18	59.1	%RH	25.6	DEGREE	101.6	hpa
4	3	2009/11/5	13:02:22	59.1	%RH	25.6	DEGREE	101.6	hpa
5	4	2009/11/5	13:02:26	58.9	%RH	25.6	DEGREE	101.6	hpa
6	5	2009/11/5	13:02:30	58.7	%RH	25.6	DEGREE	101.6	hpa
7	6	2009/11/5	13:02:34	58.4	%RH	25.6	DEGREE	101.6	hpa
8	7	2009/11/5	13:02:38	58.3	%RH	25.6	DEGREE	101.6	hpa
9	8	2009/11/5	13:02:42	58.6	%RH	25.7	DEGREE	1015.9	hpa
10	9	2009/11/5	13:02:46	58.7	%RH	25.7	DEGREE	1015.9	hpa
11	10	2009/11/5	13:02:50	58.6	%RH	25.6	DEGREE	1015.9	hpa
12	11	2009/11/5	13:02:54	58.7	%RH	25.7	DEGREE	1015.9	hpa
13	12	2009/11/5	13:02:58	58.3	%RH	25.7	DEGREE	1015.9	hpa
14	13	2009/11/5	13:03:02	59.1	%RH	25.7	DEGREE	1015.9	hpa
15	14	2009/11/5	13:03:06	59.1	%RH	25.7	DEGREE	1015.9	hpa

EXCEL graphic screen ( for example )

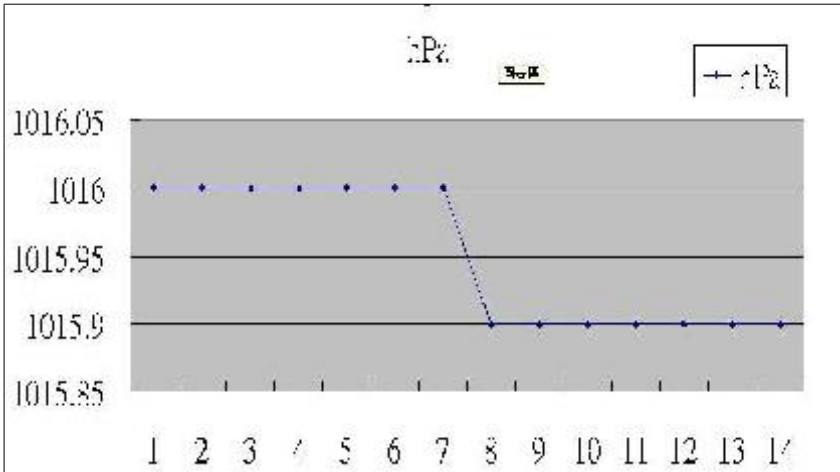

## 7. ADVANCED SETTING

Under do not execute the Datalogger function, press the " SET button " ( 3-5, Fig. 1 ) > 2 seconds continuously will enter the " Setting " mode., then release the " SET button ". Following press the " SET button " (3-5, Fig. 1 ) once a while in sequence to select the eight main function, the display will show :

**Sd F.....** SD memory card Format

**dAtE.....**Set clock time ( Year/Month/Date, Hour/Minute/Second )

**SP-t.....** Set sampling time

**bBEEP.....**Set beeper sound ON/OFF

**dEC.....**Set SD card Decimal character

**t-CF.....**Select the Temp. unit to °C or °F

**rS232.....**Set RS232 data output ON/OFF

**bAro.....**Set the unit of Barometer

**Remark :**

***During execute the " Setting " function, if within 5 seconds , do not press any buttons further, the LCD Display will return to normal screen.***

**7-1 SD memory card Format**

When the Display show " Sd F "

- 1) Use the " ▲ Button " ( 3-3, Fig. 1 ) or " ▼ Button " ( 3-4, Fig. 1 ) to select the upper value to " yES " or " no ".

**yES - Intend to format the SD memory card**  
**no - Not execute the SD memory card format**

- 2) If select the upper to " yES ", press the " Enter Button " ( 3-2, Fig. 1 ) once again, the Display will show text " yES Enter " to confirm again, if make sure to do the SD memory card format, then press " Enter Button " once will format the SD memory clear all the existing data that already saving into the SD card.

**7-2 Set clock time ( Year/Month/Date,  
Hour/Minute/ Second )**

When the Display show " dAtE "

- 1) Use the " ▲ Button " ( 3-3, Fig. 1 ) or " ▼ Button " ( 3-4, Fig. 1 ) to adjust the value ( Setting start from Year value ). After the desired value is set, press the " Enter button " ( 3-2, Fig. 1 ) once will going to next value adjustment ( for example, first setting value is Year then next to adjust Month, Date, Hour, Minute, Second value ).

*Remark :*

*The adjusted unit will be flashed.*

- 2) After set all the time value ( Year, Month, Date, Hour, Minute, Second ), press the " SET button " ( 3-5, Fig. 1 ) once will save the time value, then the screen will jump to " Sampling time " setting screen ( Chapter 7-3 ).

*Remark :*

*After the time value is setting, the internal clock will run precisely even Power off if the battery is under normal condition ( No low battery power ).*

### **7-3 Set sampling time**

When the Display show " SP-t "

- 1) Use the " ▲ Button " ( 3-3, Fig. 1 ) or " ▼ Button " ( 3-4, Fig. 1 ) to adjust the sampling value :

***5 seconds, 10 seconds, 30 seconds, 60 seconds, 120 seconds, 300 seconds, 600 seconds, Auto***

After the desired value is set, press the " Enter Button " ( 3-2, Fig. 1 ) to save the adjusting value with default.

*Remark :*

*The " Auto " sampling time means when the measuring value is changed (  $> \pm 1 \%RH$  or  $> \pm 1 ^\circ C$  ) will save the data to the memory circuit one time.*

### **7-4 Set beeper sound ON/OFF**

When the Display show " bEEP "

- 1) Use the " ▲ Button " ( 3-3, Fig. 1 ) or " ▼ Button " ( 3-4, Fig. 1 ) to select the data to " yES " or " no ".

- yES - Meter's beep sound will be ON with default when save each data.**
- no - Meter's beep sound will be OFF with default. when save each data.**

2) After select the upper text to " yES " or " no ", press the " Enter Button " ( 3-2, Fig. 1 ) will save the setting function with default.

### ***7-5 Decimal point of SD card setting***

When the Display show " dEC "

The numerical data structure of SD card is used the " . " as the decimal with default, for example "20.6" "1000.53" . But in certain countries ( Europe ...) is used the " , " as the decimal point, for example " 20,6 " "1000,53". Under such situation, it should change the Decimal character at first.

1) Use the " ▲ Button " ( 3-3, Fig. 1 ) or " ▼ Button " ( 3-4, Fig. 1 ) to select the upper text to " USA " or " Euro ".

- USA - Use " . " as the Decimal point with default.**
- Euro - Use " , " as the Decimal point with default.**

2) After select the text to " USA " or " Euro ", press the " Enter Button " ( 3-2, Fig. 1 ) will save the setting function with default.

## **7-6 Select the Temp. unit to °C or °F**

When the Display show " t-CF "

- 1) Use the " ▲ Button " ( 3-3, Fig. 1 ) or " ▼ Button " ( 3-4, Fig. 1 ) to select the upper Display text to " C " or " F ".

**C - Temperature unit is °C**

**F - Temperature unit is °F**

- 2) After Display unit is selected to " C " or " F ", press the " Enter Button " ( 3-2, Fig. 1 ) will save the setting function with default.

## **7-7 Set RS232 data output ON/OFF**

When the Display show " rS232 "

- 1) Use the " ▲ Button " ( 3-3, Fig. 1 ) or " ▼ Button " ( 3-4, Fig. 1 ) to select the upper Display text to "yES " or " no ".

**yES - RS-232 output terminal ( 3-12, Fig. 1 )  
will send the RS232 signal output.**

**no - RS-232 output terminal ( 3-12, Fig. 1 )  
will not send the RS232 signal output.**

- 2) After Display text is selected to " yES " or " no ", press the " Enter Button " ( 3-2, Fig. 1 ) will save the setting function with default.



## **7-8 Set the unit of Barometer**

When the Display show " bAro "

- 1) Use the " ▲ Button " ( 3-3, Fig. 1 ) or " ▼ Button " ( 3-4, Fig. 1 ) to select the upper Display text to hPA ", " - Hg " or " InHg ".

<i>Text</i>	<i>Unit</i>
<b>hPA</b>	hPa
<b>- HG</b>	mmHg
<b>InHg</b>	inHg

- 2) After the unit is selected, press the " Enter Button " ( 3-2, Fig. 1 ) will save the setting function with default.

## **8. POWER SUPPLY from DC ADAPTER**

The meter also can supply the power supply from the DC 9V Power Adapter ( optional ). Insert the plug of Power Adapter into " DC 9V Power Adapter Input Socket " ( 3-14, Fig. 1 ).

## 9. BATTERY REPLACEMENT

- 1) When the left corner of LCD display show " , it is necessary to replace the battery. However, in-spec. measurement may still be made for several hours after low battery indicator appears before the instrument become inaccurate.
- 2) Loose the " Screw of the battery cover " ( 3-10, Fig. 1 ) and take away the " Battery Cover " ( 3-9, Fig. 1 ) from the instrument and remove the battery.
- 3) Replace with DC 1.5 V battery ( UM4/AAA, Alkaline/heavy duty ) x 6 PCs, and reinstate the cover.
- 4) Make sure the battery cover is secured after changing the battery.

## 10. SYSTEM RESET

If the meter happen the troubles such as :

*CPU system is hold ( for example, the key button can not be operated... ).*

Then make the system RESET will fix the problem.  
The system RESET procedures will be either following method :

During the power on, use a pin to press the " Reset Button " ( 3-11, Fig. 1 ) once a while will reset the circuit system.

# 11. RS232 PC SERIAL INTERFACE

The instrument has RS232 PC serial interface via a 3.5 mm terminal ( 3-12, Fig. 1 ) if the RS232 function already select to " ON ", refer to chapter 7-7, page 14.

The data output is a 16 digit stream which can be utilized for user's specific application.

A RS232 lead with the following connection will be required to link the instrument with the PC serial port.

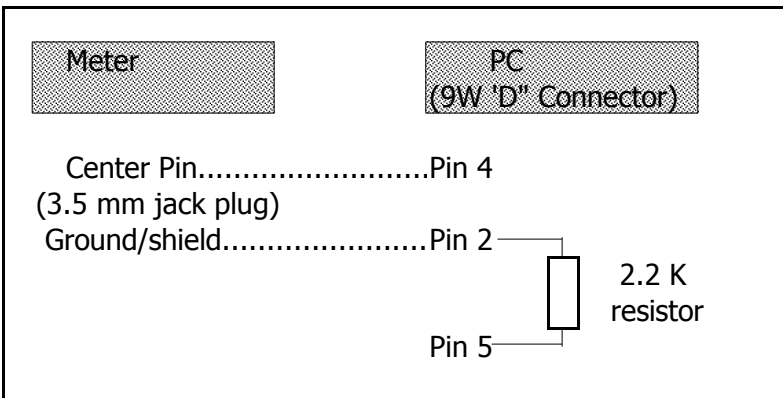

The 16 digits data stream will be displayed in the following format :

D15 D14 D13 D12 D11 D10 D9 D8 D7 D6 D5 D4 D3 D2 D1 D0

## Each digit indicates the following status :

D0	End Word
D1 & D8	Display reading, D1 = LSD, D8 = MSD For example : If the display reading is 1234, then D8 to D1 is : 00001234

D9	Decimal Point(DP), position from right to the left 0 = No DP, 1= 1 DP, 2 = 2 DP, 3 = 3 DP		
D10	Polarity 0 = Positive 1 = Negative		
D11 & D12	Annunciator for Display		
	°C = 01	°F = 02	% RH = 04
	hPa = 91	inch Hg = 80	mm Hg = 78
D13	When send the up display data = 1 When send the middle display data = 2 When send the low display data = 3		
D14	4		
D15	Start Word		

### RS232 FORMAT : 9600, N, 8, 1

Baud rate	9600
Parity	No parity
Data bit no.	8 Data bits
Stop bit	1 Stop bit

## 12. PATENT

The meter ( SD card structure ) already get patent or patent pending in following countries :

Germany	Nr. 20 2008 016 337.4
JAPAN	3151214
TAIWAN	M 358970
	M 359043
CHINA	ZL 2008 2 0189918.5
	ZL 2008 2 0189917.0
USA	Patent pending